

BAL HARBOUR

- V I L L A G E -

UPDATE #32 COVID-19

April 14, 2020 (5:00 PM)

The Village Emergency Operations Team is working hard to ensure the health and well-being of the community. As we continue to monitor the latest information on COVID-19 (Coronavirus), updated information will be shared with the community. The following are updates for today:

COVID-19 Drive-Thru Testing Clinic to Open in Aventura

Banyan Medical Systems and Pivot Concierge Health have partnered with the City of Aventura to open a drive thru COVID-19 rapid testing site at the Aventura Mall (testing is conducted at the Expansion Parking Garage next to Macy's/new Apple Store/Tap 42 Restaurant).

We have confirmed that this testing is available to residents of Bal Harbour Village.

Testing appointments are required and must be made through an online screening questionnaire at covidaventura.com. Seniors age 65 and older will be given immediate access to testing by completing the online questionnaire or calling 402-885-8125. All others are by appointment.

Testing is conducted between the hours of 9:00 a.m. and 5:00 p.m., Monday - Friday **by appointment only**. Appointment windows are open every 48-72 hours, so please check the covidaventura.com website each day for appointment availability for the next 48-72 hours.

United States Census 2020

In light of the COVID-19 outbreak, the U.S. Census Bureau has extended the deadline for the 2020 Census. The [2020 Census Questionnaire](#) should only take most people 10 minutes to complete, and your response helps direct billions of dollars in funds to local communities for roads and other important public services.

Most households should have already received their invitation to respond to the 2020 Census. These official Census Bureau mailings will include detailed information and a Census ID for [completing the Census online](#).

In addition to an invitation to respond, some households will receive a paper questionnaire. You do not need to wait for your paper questionnaire to respond to the Census. We encourage you to complete your census form online, by phone. To learn more about Census 2020 please visit www.2020census.gov.

Restaurants Open for Take-out & Delivery at The Bal Harbour Shops

The following Bal Harbour restaurants are open for takeout and delivery:

- [Hillstone Bal Harbour](#) is open 11:30 AM to 8:30 PM, call the restaurant at 786.260.6650.
- [Makoto Bal Harbour](#) will re-open on Wednesday, April 15 from 12:00 PM to 8:00 PM, call the restaurant at 305.864.8600.

Miami-Dade County Order Relative to Face Coverings

On April 9, 2020, Miami-Dade County issued Emergency Order 20-20, relative to face coverings. Following are the requirements of this order:

- (1) Persons working in or visiting grocery stores, restaurants, pharmacies, construction sites, public transit vehicles, vehicles for hire, and locations where social distancing measures are not possible shall wear facial coverings as defined by the CDC.
- (2) A facial covering includes any covering which snugly covers the face and mouth, whether store bought or homemade, and which is secured with ties or ear loops.
- (3) A mask shall not be required for children under two or persons who have trouble breathing due to a chronic pre-existing condition.

For examples of compliant face coverings, and instructions on how to make one, visit the [CDC website](#). The Do It Yourself (DIY) instructions for face coverings are attached to this update.

Testing Sites

Please be advised that the number of testing sites continues to expand and the minimum requirements to qualify to be tested are also continuing to change. For a complete listing of testing site locations and hours, please visit the [Miami-Dade County Coronavirus webpage](#).

Frequently Asked Questions (FAQs)

We have also refreshed our list of frequently asked questions from residents of Bal Harbour Village, for your convenience, regarding the Coronavirus. A copy of the updated "FAQs" can be downloaded at <https://bit.ly/2K3vL8U>.

Use of Cloth Face Coverings to Help Slow the Spread of COVID-19

How to Wear Cloth Face Coverings

Cloth face coverings should—

- fit snugly but comfortably against the side of the face
- be secured with ties or ear loops
- include multiple layers of fabric
- allow for breathing without restriction
- be able to be laundered and machine dried without damage or change to shape

CDC on Homemade Cloth Face Coverings

CDC recommends wearing cloth face coverings in public settings where other social distancing measures are difficult to maintain (e.g., grocery stores and pharmacies), **especially** in areas of significant community-based transmission.

CDC also advises the use of simple cloth face coverings to slow the spread of the virus and help people who may have the virus and do not know it from transmitting it to others. Cloth face coverings fashioned from household items or made at home from common materials at low cost can be used as an additional, voluntary public health measure.

Cloth face coverings should not be placed on young children under age 2, anyone who has trouble breathing, or is unconscious, incapacitated or otherwise unable to remove the cloth face covering without assistance.

The cloth face coverings recommended are not surgical masks or N-95 respirators. Those are critical supplies that must continue to be reserved for healthcare workers and other medical first responders, as recommended by current CDC guidance.

Should cloth face coverings be washed or otherwise cleaned regularly? How regularly?

Yes. They should be routinely washed depending on the frequency of use.

How does one safely sterilize/clean a cloth face covering?

A washing machine should suffice in properly washing a cloth face covering.

How does one safely remove a used cloth face covering?

Individuals should be careful not to touch their eyes, nose, and mouth when removing their cloth face covering and wash hands immediately after removing.

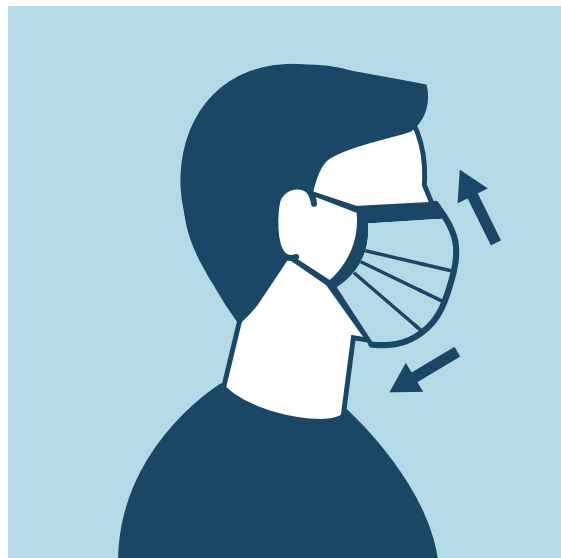

Sewn Cloth Face Covering

Materials

- Two 10"x6" rectangles of cotton fabric
- Two 6" pieces of elastic (or rubber bands, string, cloth strips, or hair ties)
- Needle and thread (or bobby pin)
- Scissors
- Sewing machine

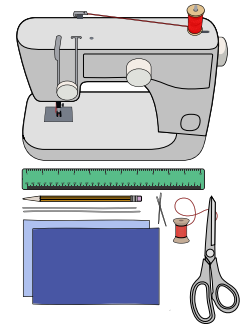

Tutorial

1. Cut out two 10-by-6-inch rectangles of cotton fabric. Use tightly woven cotton, such as quilting fabric or cotton sheets. T-shirt fabric will work in a pinch. Stack the two rectangles; you will sew the cloth face covering as if it was a single piece of fabric.

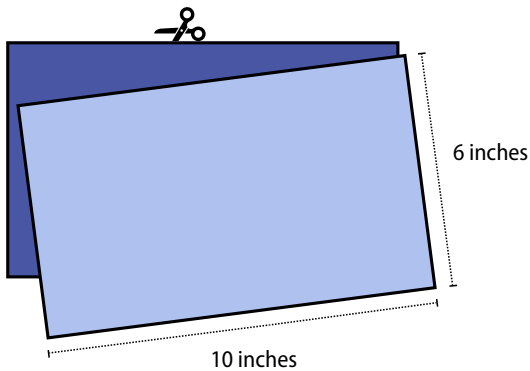

2. Fold over the long sides $\frac{1}{4}$ inch and hem. Then fold the double layer of fabric over $\frac{1}{2}$ inch along the short sides and stitch down.

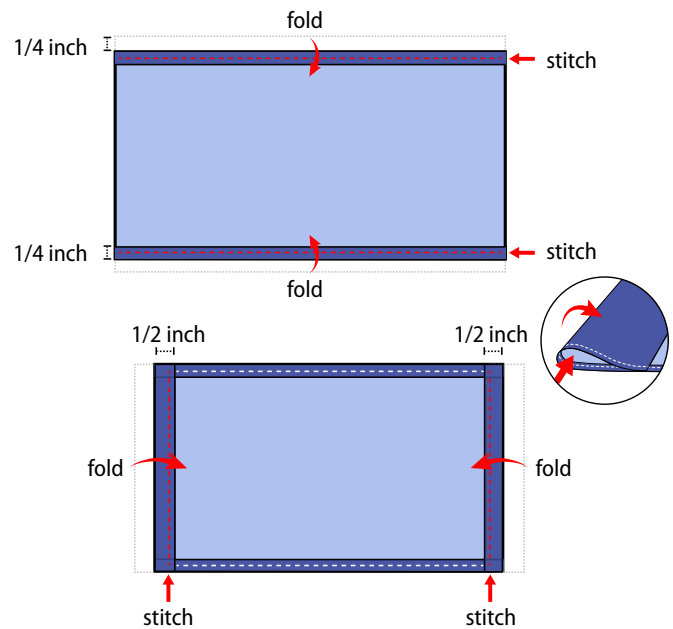

3. Run a 6-inch length of $\frac{1}{8}$ -inch wide elastic through the wider hem on each side of the cloth face covering. These will be the ear loops. Use a large needle or a bobby pin to thread it through. Tie the ends tight. Don't have elastic? Use hair ties or elastic head bands. If you only have string, you can make the ties longer and tie the cloth face covering behind your head.

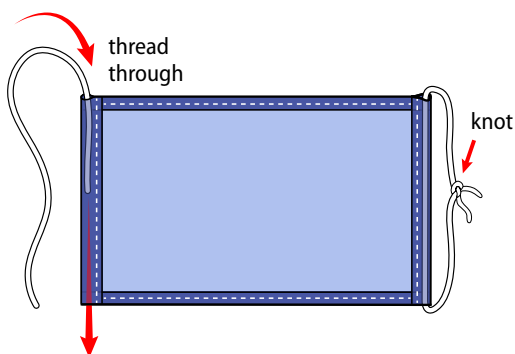

4. Gently pull on the elastic so that the knots are tucked inside the hem. Gather the sides of the cloth face covering on the elastic and adjust so the cloth face covering fits your face. Then securely stitch the elastic in place to keep it from slipping.

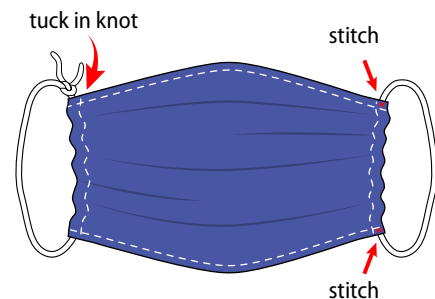

Quick Cut T-shirt Cloth Face Covering (no sew method)

Materials

- T-shirt
- Scissors

Tutorial

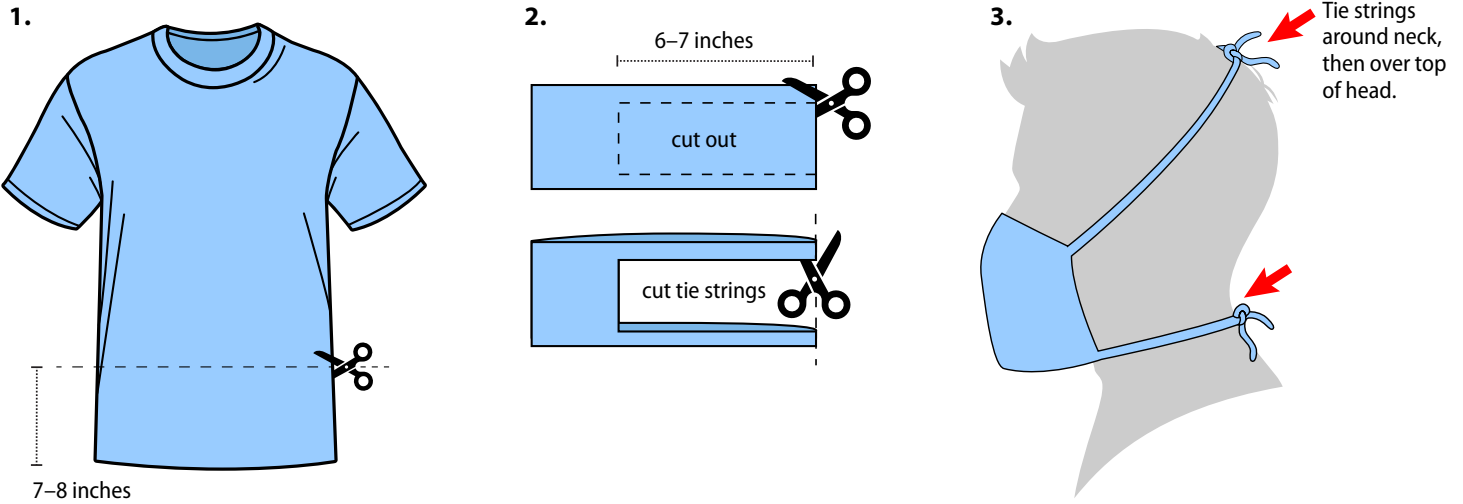

Bandana Cloth Face Covering (no sew method)

Materials

- Bandana (or square cotton cloth approximately 20"x20")
- Coffee filter
- Rubber bands (or hair ties)
- Scissors (if you are cutting your own cloth)

Tutorial

